

## Fixation par pince

## Fixation par vis

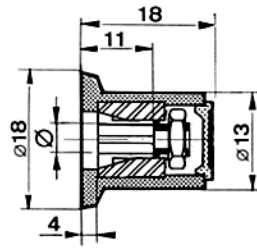

Ø	REFERENCE
3	312-03-39
4	312-03-49
5	312-03-59
6	312-03-69
1/8"	312-03-19
1/4"	312-03-29

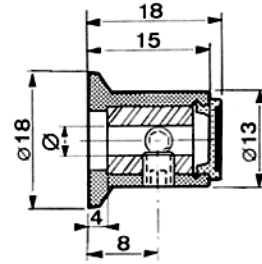

Ø	REFERENCE
3	112-03-39
4	112-03-49
6	112-03-69
1/8"	112-03-19
1/4"	112-03-29

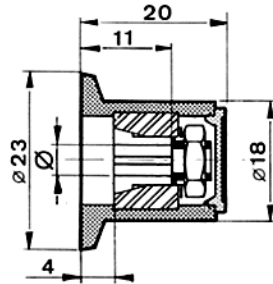

Ø	REFERENCE
3	312-04-39
4	312-04-49
5	312-04-59
6	312-04-69
1/8"	312-04-19
1/4"	312-04-29

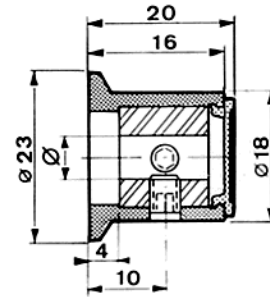

Ø	REFERENCE
3	112-04-39
4	112-04-49
6	112-04-69
1/8"	112-04-19
1/4"	112-04-29

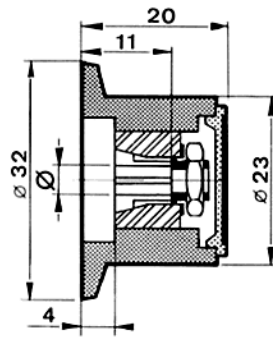

Ø	REFERENCE
3	312-05-39
4	312-05-49
5	312-05-59
6	312-05-69
1/8"	312-05-19
1/4"	312-05-29

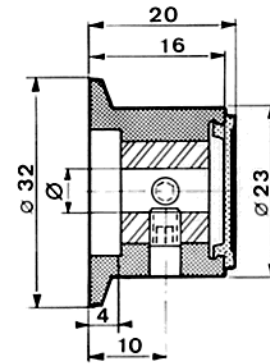

Ø	REFERENCE
4	112-05-49
6	112-05-69
1/4"	112-05-29

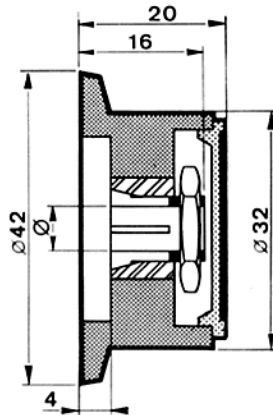

Ø	REFERENCE
4	312-06-49
5	312-06-59
6	312-06-69
1/4"	312-06-29

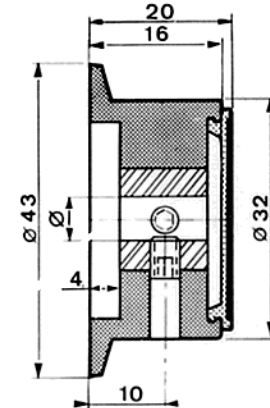

Ø	REFERENCE
4	112-06-49
6	112-06-69
8	112-06-89
10	112-06-09
1/4"	112-06-29

## A vis seulement

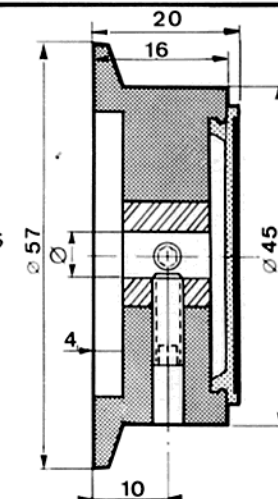
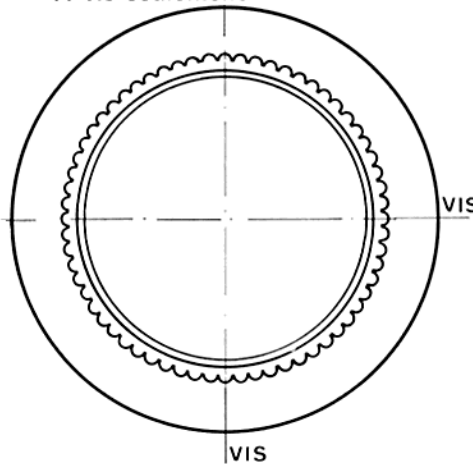

Ø	REFERENCE
4	112-07-49
6	112-07-69
8	112-07-89
10	112-07-09
1/4"	112-07-29